

Visions 2000 Sliding Patio Door/ French Sliding Patio Door Parts Reference Catalog

1018145 (Revised 3/01)

VISIONS 2000[®]

Vinyl Windows & Doors



Weather Shield Mfg., Inc.
Medford, WI 54451 • 715/748-2100



Table of Contents

| | |
|---|---------|
| Parts Reference Catalog Guide | Page 1 |
| Sliding Patio Door Cross Sections | Page 2 |
| Sliding Patio Door Horizontal/Vertical Mull Cross Sections | Page 4 |
| French Sliding Patio Door Horizontal/Vertical Mull Cross Sections | Page 5 |
| Sliding Patio Door How To Measure To Order Replacement Parts | Page 6 |
| French Sliding Patio Door How To Measure To Order Replacement Parts | Page 8 |
| Sliding Patio Door and Transom Sizes | Page 10 |
| Sliding Patio Door Glazing Option | Page 10 |
| Sliding Patio Door Glass Replacement Order Form | Page 11 |
| Sliding Patio Door Insert Replacement Order Form | Page 12 |
| Sliding Patio Door Inserts, Glass, and Glazing Bead | Page 13 |
| Sliding Patio Door Screen Parts | Page 14 |
| Sliding Patio Door Parts | |
| Horizontal | Page 16 |
| Vertical | Page 17 |
| Miscellaneous | Page 19 |
| Accessories | Page 29 |

Parts Reference Catalog Guide



Please specify product option numbers or part numbers when ordering.

PURPOSE

This catalog is intended to assist you in identifying and ordering replacement parts.

CATALOG FORMAT

1) Cross Section Pages (Pages 2-3)

Shows part locations on a complete unit.

Each part name is shown at the bottom of the page with a reference page number to turn to for specific information on that part.

2) "Measuring Your Unit" Page (Pages 6-9)

After the cross section pages is an informational page explaining how to measure your unit to order correct replacement part sizes.

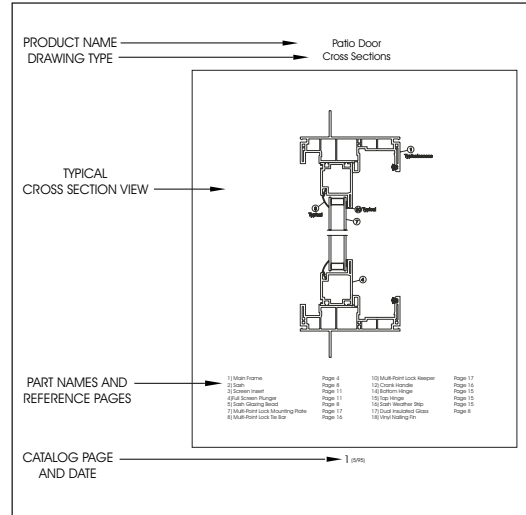

3) Detailed Parts Information Pages (Pages 13-31)

Pages are organized under four general categories: Horizontal, Vertical, Sash-Glass-Screens, Miscellaneous, and Accesories Parts Pages.

Drawings of the parts and their descriptions are shown at the left of the page as they will show up on your order acknowledgement.

Product options and part numbers are shown at the right for you to specify when ordering.

At the end of some part descriptions are brackets with "S" or "E" followed by dates. This indicates when parts were started or ended in production.

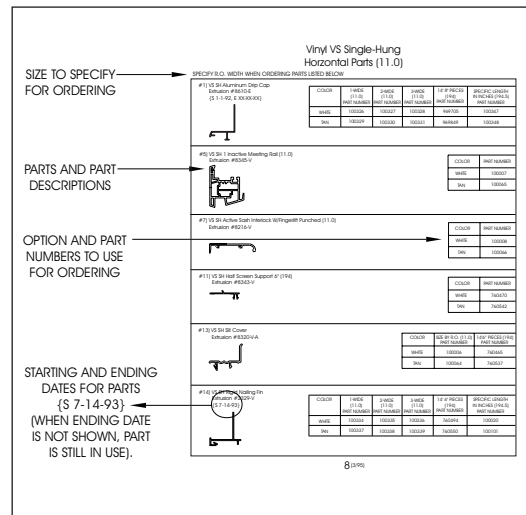

GLASS IDENTIFICATION NUMBERS

To identify when your unit was produced, look for the black ink numbers stamped on the aluminum spacer between the lites of glass. It will be near one of the four corners. See sketch at right.

QUESTIONS

Contact your Customer Service Representative if you have any questions concerning how to use parts reference catalogs.

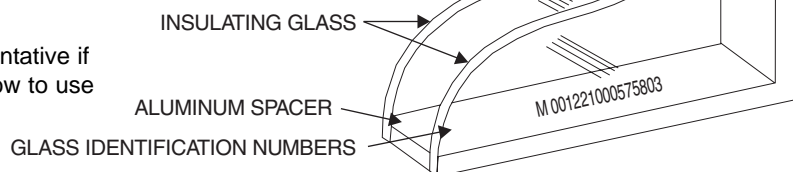



Sliding Patio Door Side View Cross Sections

VISIONS 2000

Unit Shown is Not to Scale. When ordering Parts, view the unit from the Exterior.

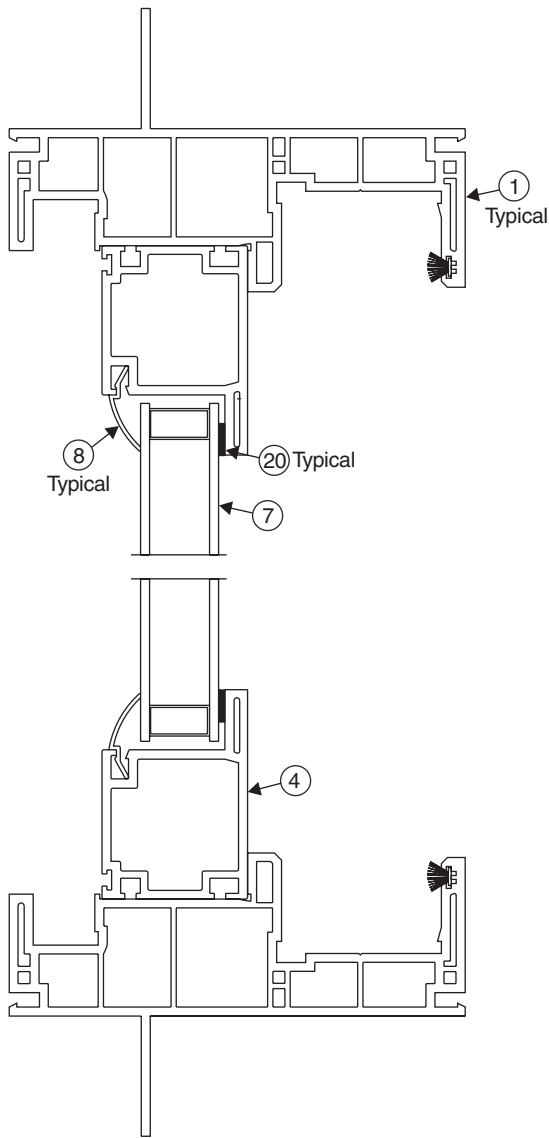

Stationary and Transom Side View

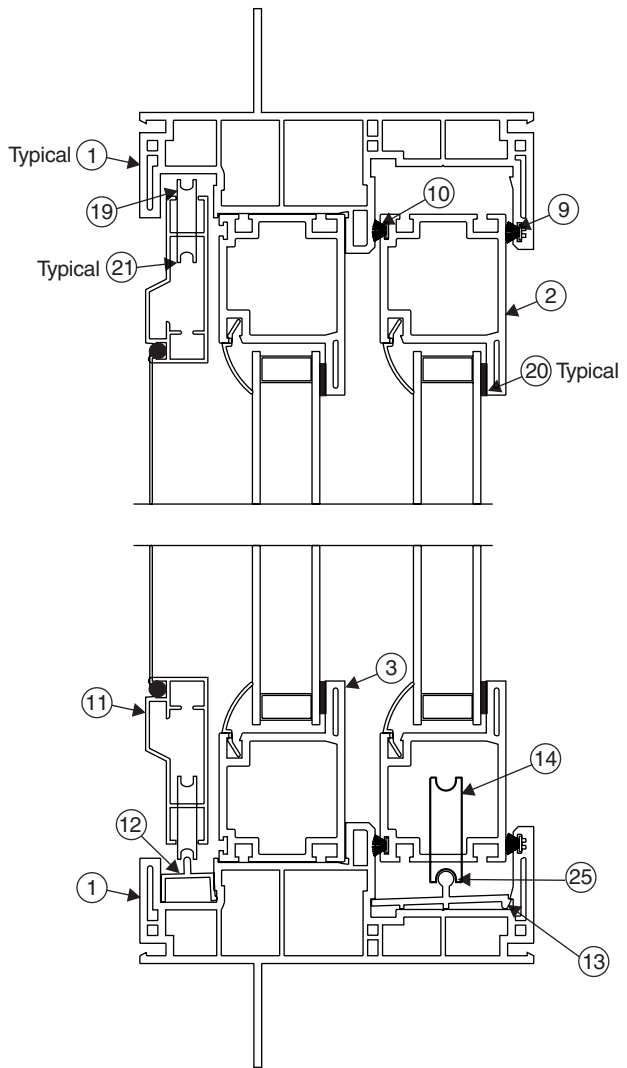

Operating Side View

- | | | | |
|--------------------------------------|---------|--------------------------------|---------|
| 1) Main Frame | | 11) Screen | Page 14 |
| 2) Active Insert | Page 13 | 12) Screen Track | Page 15 |
| 3) Inactive Insert | Page 13 | 13) Sill Track w/Cap | Page 16 |
| 4) Stationary Insert | Page 13 | 14) Patio Door Roller | Page 19 |
| 7) Insul Glass | Page 13 | 19) Screen Door Top Rail Guide | Page 15 |
| 8) Glazing Bead | Page 13 | 20) Double Face Glazing Tape | Page 20 |
| 9) Pile Weather Strip w/o Center Fin | Page 18 | 21) Screen Roller Assembly | Page 15 |
| 10) Pile Weather Strip w/Center Fin | Page 19 | 25) Stainless Steel Track Cap | Page 16 |

Sliding Patio Door Top View Cross Sections



Unit Shown is Not to Scale. When ordering Parts, view the unit from the Exterior.

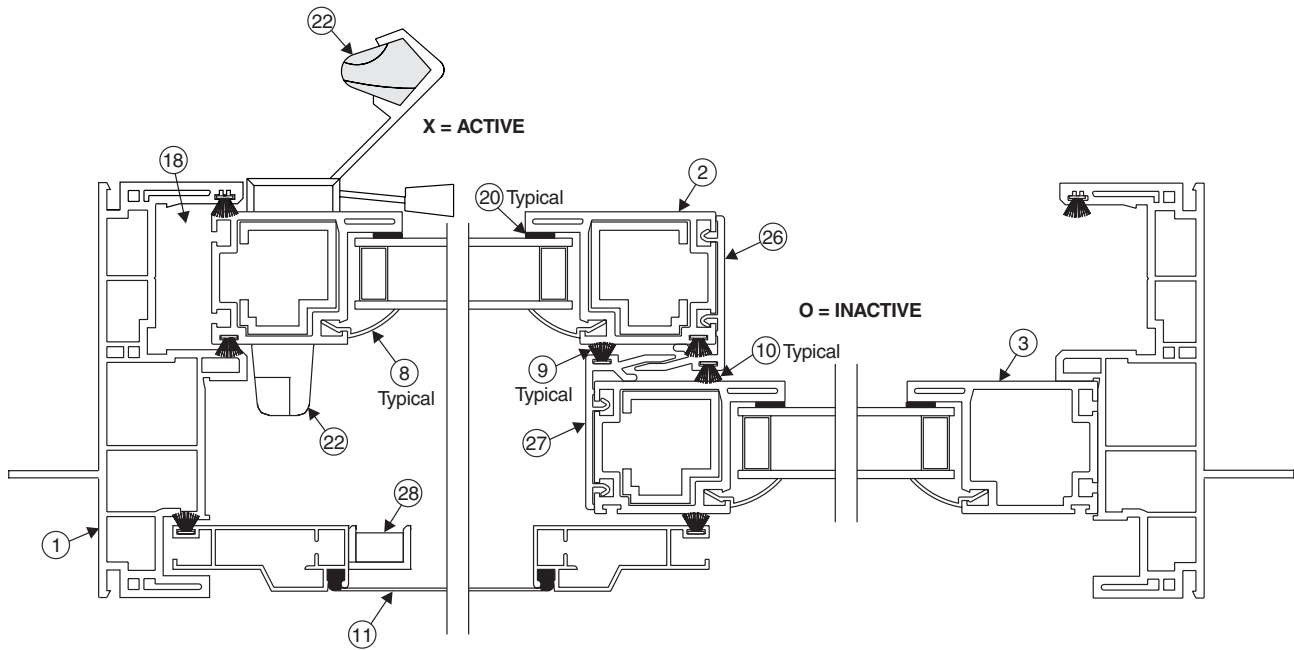

2 Panel Top View - XO Shown

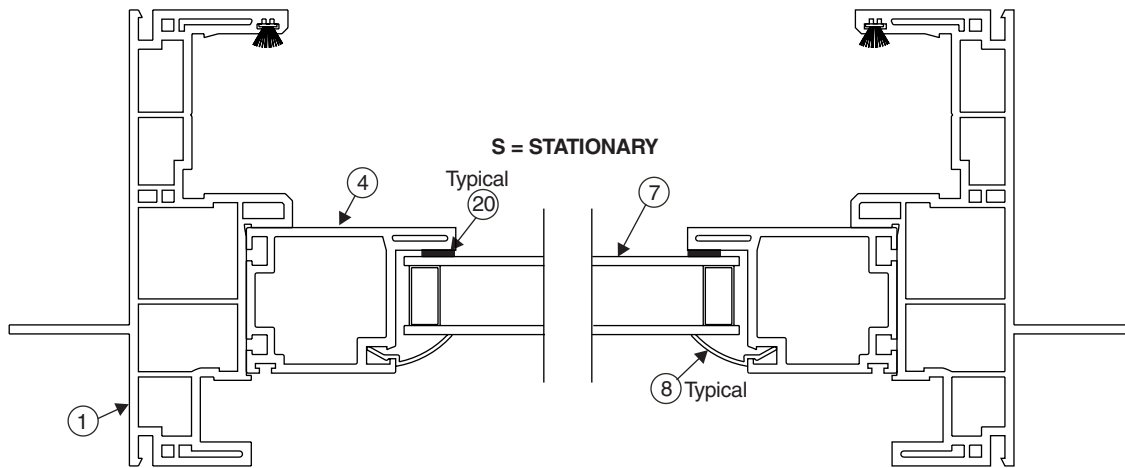

Stationary and Transom Top View

- | | | | |
|--------------------------------------|---------|-------------------------------|---------|
| 1) Main Frame | | 11) Screen | Page 14 |
| 2) Active Insert | Page 13 | 18) Jamb Latch Keeper | Page 23 |
| 3) Inactive Insert | Page 13 | 20) Double Face Glazing Tape | Page 20 |
| 4) Stationary Insert | Page 13 | 22) Handle Set | Page 22 |
| 7) Insul Glass | Page 13 | 26) Active Insert Interlock | Page 17 |
| 8) Glazing Bead | Page 13 | 27) Inactive Insert Interlock | Page 17 |
| 9) Pile Weather Strip w/o Center Fin | Page 18 | 28) Screen Handle Set | Page 15 |
| 10) Pile Weather Strip w/Center Fin | Page 19 | | |



VISIONS 2000

Sliding Patio Door Horizontal/Vertical Mull Cross Sections

Unit Shown is Not to Scale. When ordering Parts, view the unit from the Exterior.

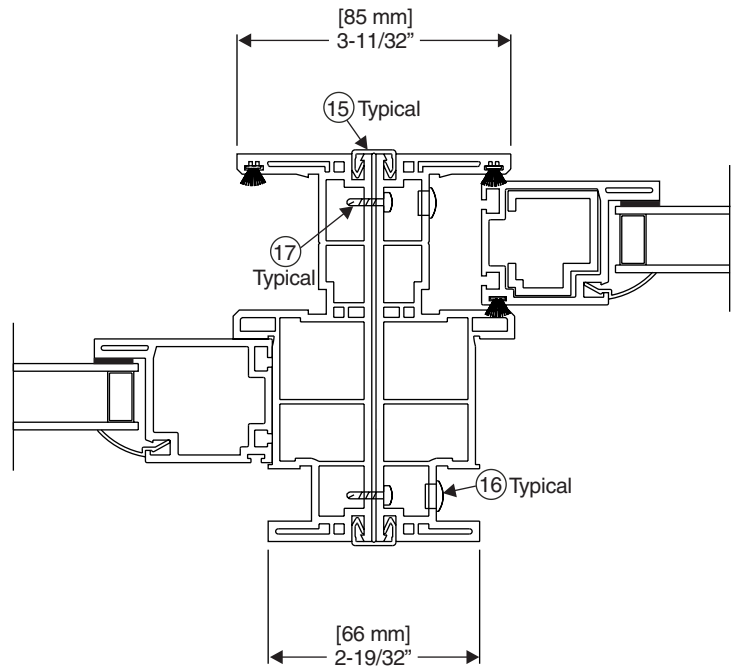

Vertical Mull Detail

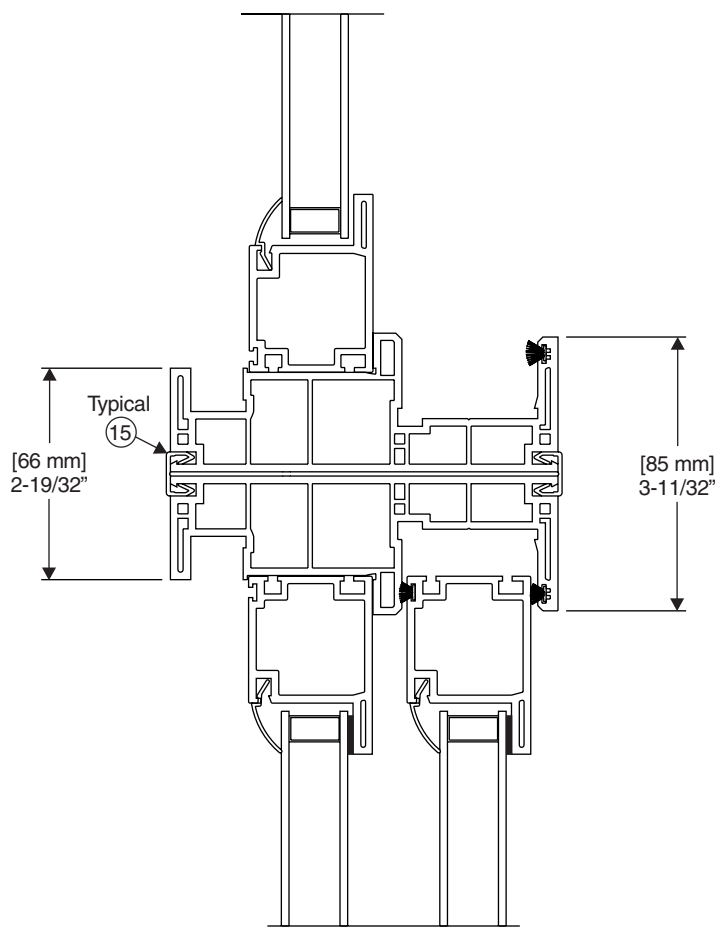

Horizontal Stack Detail

- | | |
|--|---------------|
| 15) Interior/Exterior Small Mull Cover | Pages 16 & 18 |
| 16) 3/8" Hole Plug | Page 19 |
| 17) #8 x 1/2" Tek Panhead Screw | Page 19 |

French Sliding Patio Door Horizontal/Vertical Mull Cross Sections



Unit Shown is Not to Scale. When ordering Parts, view the unit from the Exterior.

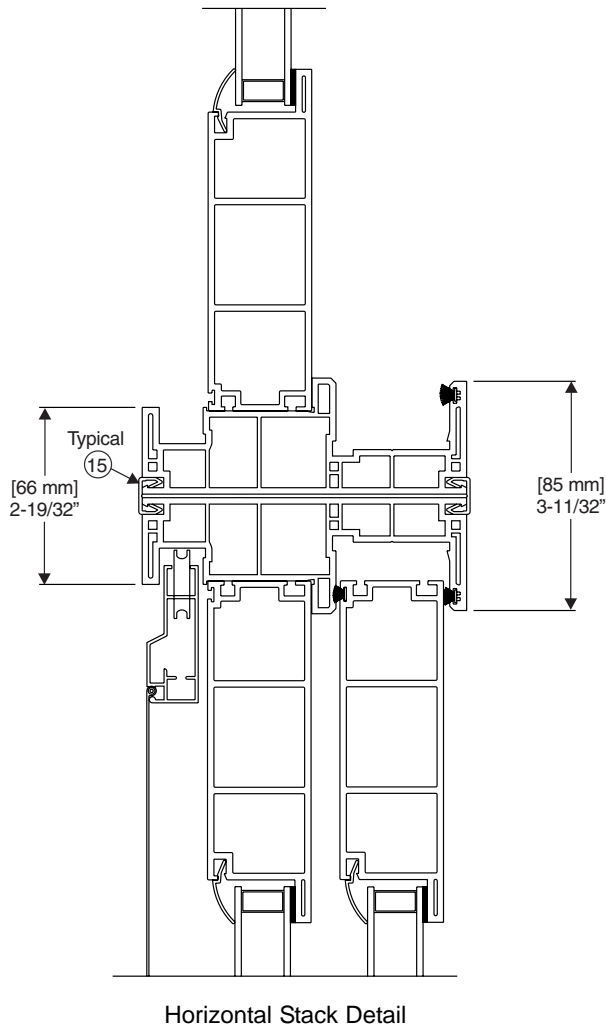
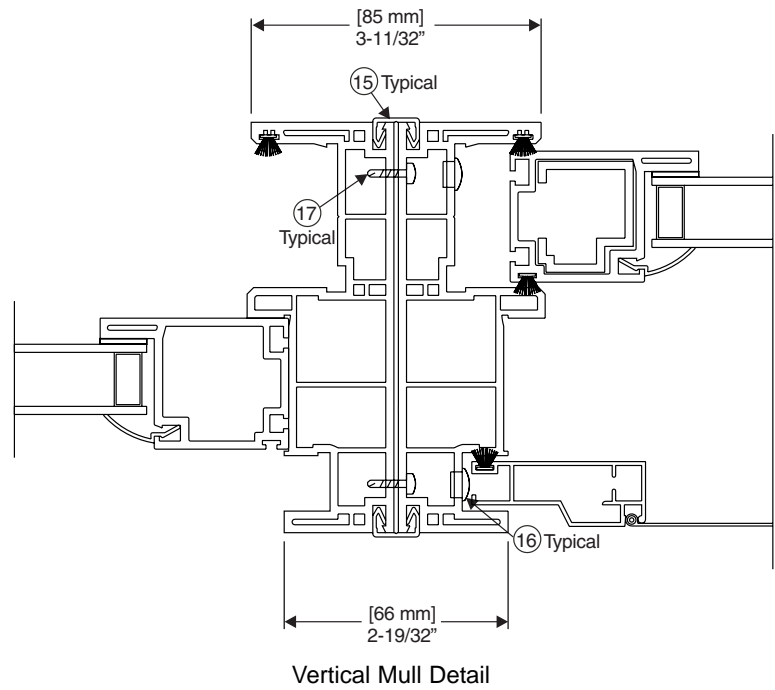

- | | |
|--|---------------|
| 15) Interior/Exterior Small Mull Cover | Pages 16 & 18 |
| 16) 3/8" Hole Plug | Page 19 |
| 17) #8 x 1/2" Tek Panhead Screw | Page 19 |



Sliding Patio Door

How To Measure To Order Replacement Parts

Stationary/Transom Side View

- Frame Dimension Height $1/4" = \text{R.O.}$
- Insert Height $+ 2-11/16" = \text{R.O.}$
- Glass Height $+ 6" = \text{R.O.}$
- Daylite Opening Height $+ 7-1/16" = \text{R.O.}$
- Screen Height $+ 2-9/16" = \text{R.O.}$

Stationary/Transom Top View

- Frame Dimension Width $+ 1/2" = \text{R.O.}$
- Insert Width $+ 2-31/32" = \text{R.O.}$
- Glass Width $+ 6-1/4" = \text{R.O.}$
- Daylite Opening Width $+ 7-5/16" = \text{R.O.}$

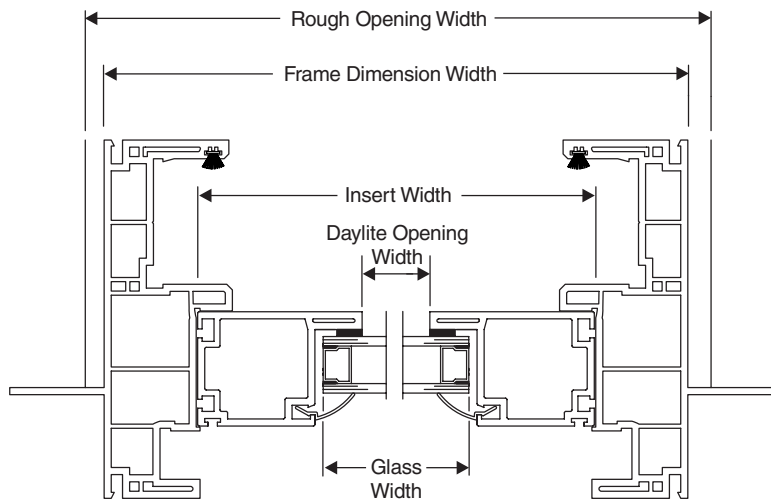
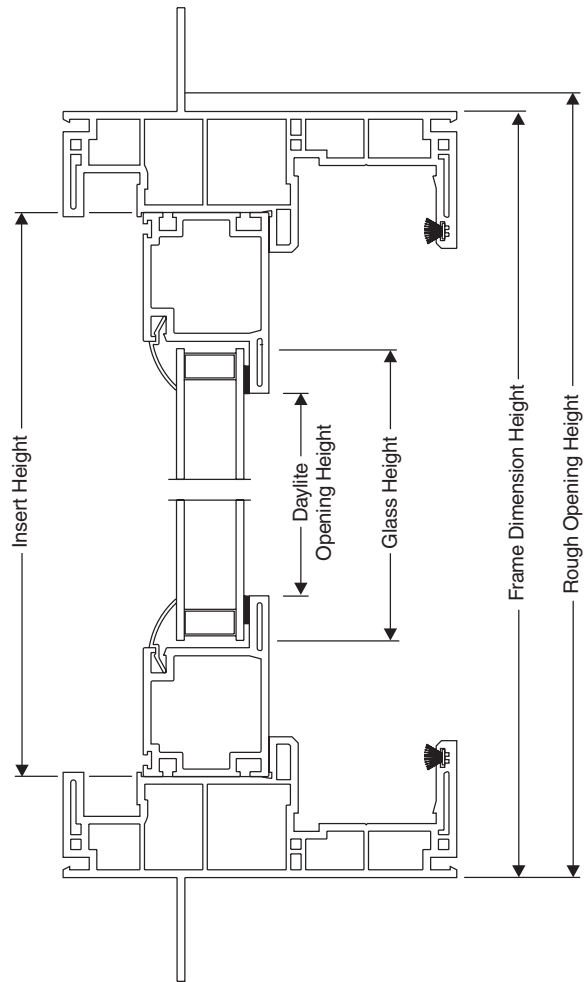

Sliding Patio Door How To Measure To Order Replacement Parts



Operating Side View

- Frame Dimension Height $1/4" = \text{R.O.}$
- Insert Height $+ 2-11/16" = \text{R.O.}$
- Glass Height $+ 6" = \text{R.O.}$
- Daylite Opening Height $+ 7-1/16" = \text{R.O.}$
- Screen Height $+ 2-9/16" = \text{R.O.}$

2 Panel Top View

- Frame Dimension Width $+ 1/2" = \text{R.O.}$
- Insert Width $+ 27/32" \times 2 = \text{R.O.}$
- Glass Width $+ 4-1/8" \times 2 = \text{R.O.}$
- Daylite Opening Width $+ 5-3/16" \times 2 = \text{R.O.}$
- Screen Width $- 1/8" \times 2 = \text{R.O.}$

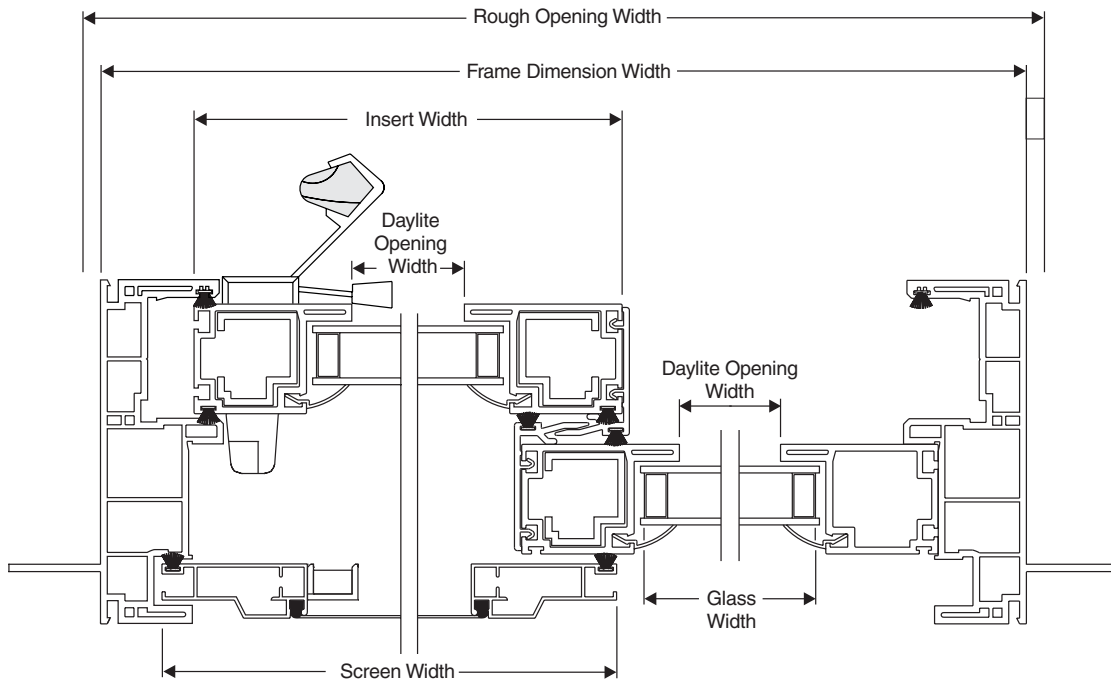
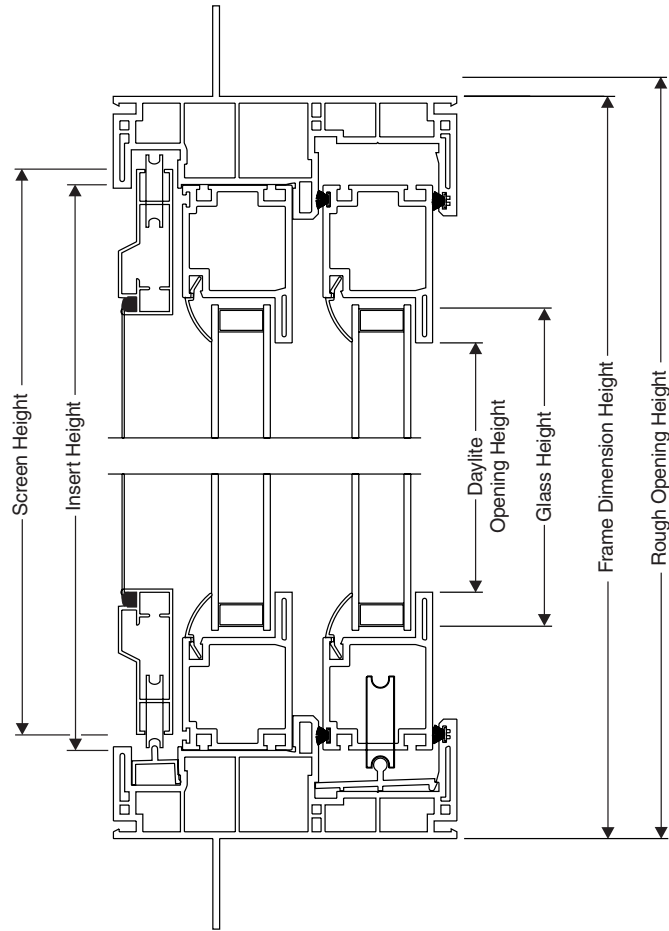



French Sliding Patio Door

How To Measure To Order Replacement Parts

Operating Side View

Frame Dimension Height = R.O. - 1/4"

Insert Height = R.O. - 2-11/16"

Glass Height = R.O. - 11-5/8"

Screen Height = R.O. - 2-9/16"

2 Panel Top View

Frame Dimension Width = R.O. - 1/2"

Insert Width = 1/2 R.O. + 9/16"

Glass Width = 1/2 R.O. - 8-3/8"

Daylite Opening Width + 5-3/16" x 2 = R.O.

Screen Width - 1/8" x 2 = R.O.

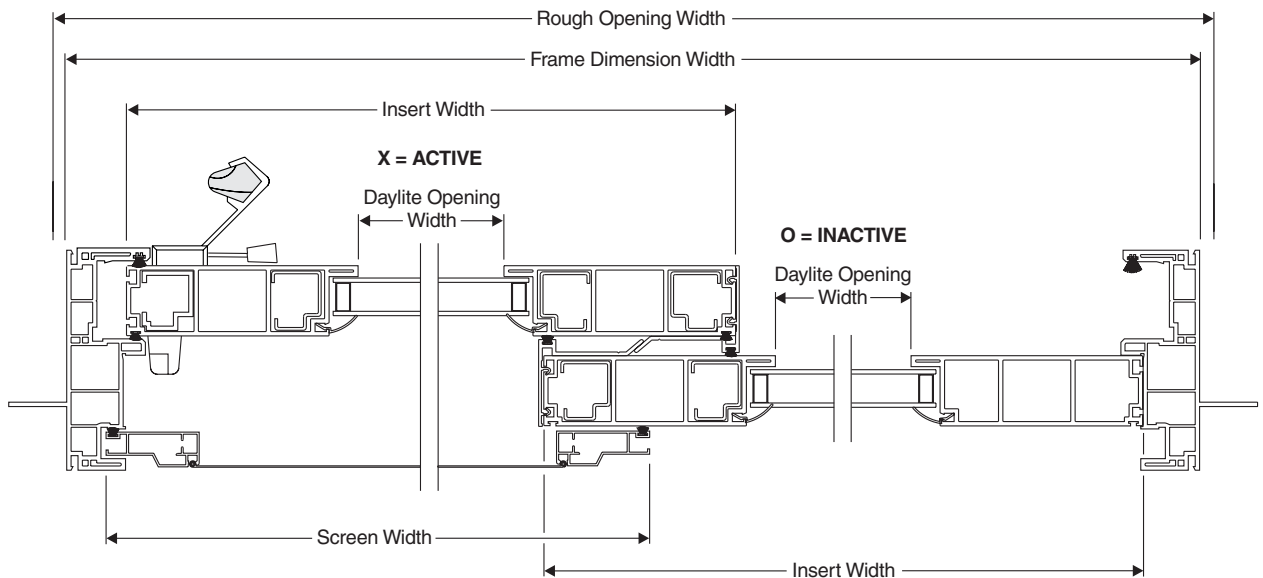
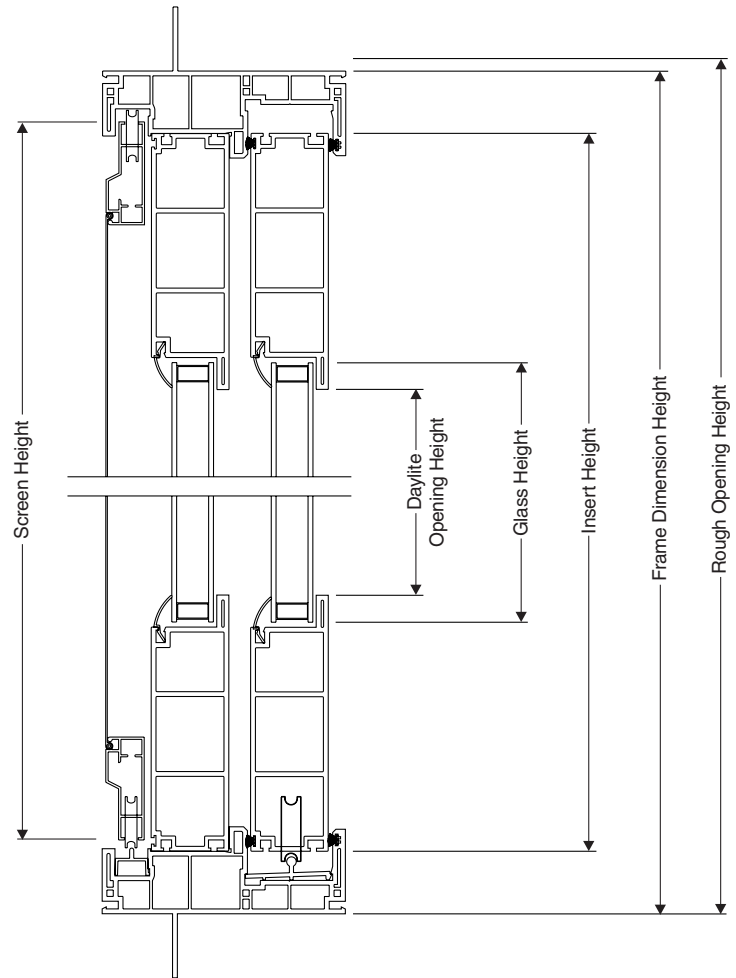

French Sliding Patio Door How To Measure To Order Replacement Parts

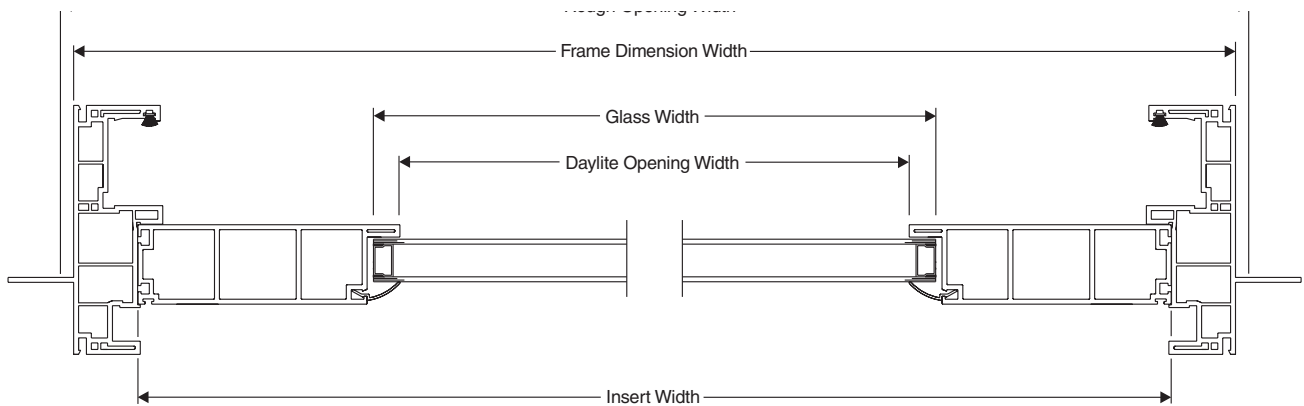

Stationary/Transom Top View for Single Doors

Frame Dimension Width = R.O. - 1/2"

Insert Width = R.O. - 2-15/16"

Glass Width = R.O. - 11-7/8"

Daylite Opening Width = R.O. - 12-15/16"

Stationary/Transom Top View for 2 Panel Doors

Frame Dimension Width = R.O. - 1/2"

Insert Width = R.O. - 2-31/32"

Glass Width = R.O. - 11-15/16"

Daylite Opening Width = R.O. - 12-15/16"



Sliding Patio Door and Transom Sizes

| Sliding Patio Door |
|--------------------|
| Rough Opening |
| 3' 2-1/8" x 6-8 |
| 5-0 x 6-8 |
| 6-0 x 6-8 |
| 8-0 x 6-8 |
| 3' 2-1/8" x 6-10 |
| 5-0 x 6-10 |
| 6-0 x 6-10 |
| 8-0 x 6-10 |
| 3' 5-1/8" x 7-0 |
| 6-6 x 7-0 |
| 3' 2-1/8" x 8-0 |
| 5-0 x 8-0 |
| 6-0 x 8-0 |

| Sliding Patio Door Transom |
|-------------------------------|
| Rough Opening |
| 3' 2-1/8" x 1-8 |
| 3' 5-1/8" x 1-8 |
| 5-0 x 1-8 |
| 6-0 x 1-8 |
| 6-6 x 1-8 |
| 8-0 x 1-8 |

NOTE: 6-8 Rough Opening Only Reversible.

Glazing Option

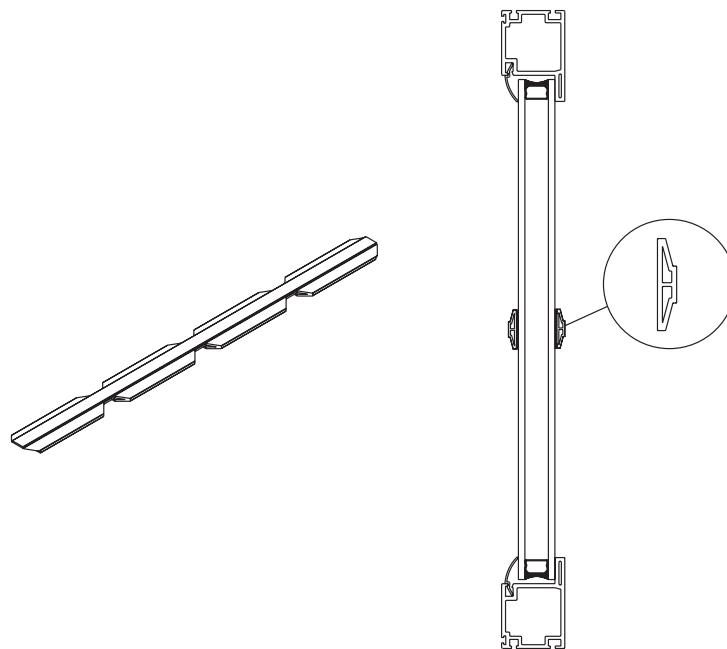

Simulated Divided Light (SDL)

Sliding Patio Door Glass Replacement Order Form



To Order Glass Only: RG (70.2) for Sliding Patio Door; RG (75.2) for French Sliding Patio Door.

To Order Replacement Glass, Specify The Following:

1) Manufacturing Date / Glass Code (See Page 1): _____

2) Rough Opening Size (See Pages 6-9):
Width: _____ Height: _____

3) Glazing Option:
 13/16" Insul

4) Spacer Color:
 Silver Anodized
 Bronze Anodized

5) Glass Type:
 Clear
 Low E
 Special Glass: (Obscure, Tinted, Patterned, Etc.) _____

SDL Configuration: Wide: _____ High: _____ (Example: Wide: 2 High: 5)
 7/8" Bar

Grille in Airspace and Configuration:

Grille Type:

5/8" Rectangular Wide: _____ High: _____
 11/16" Sculptured Rectangular Wide: _____ High: _____
 15/16" Sculptured Rectangular Wide: _____ High: _____

5/8" Diamond Number of Lites: _____ (Example: 17 Lite Diamond)

Color:

White
 VS Tan

Gas:

Argon / Krypton / SF6 (Circle Which One Applies)

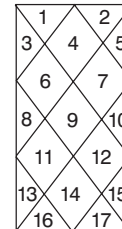
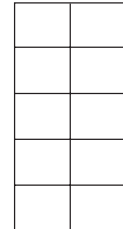

NOTE: If ordering glass only, stop here.

Continued on Next Page



VISIONS 2000

Sliding Patio Door Insert Replacement Order Form

To Order Insert Only: AIG (70.0), IIG (70.1), TRIG (70.5) for Sliding Patio Door; AIG & IIG (75.1) for French Sliding Patio Door.

6) Door Call-Out Size (See Pages 9 & 10):

7) Insert Type:

Sliding Patio Door

French Sliding Patio Door

8) Door Operation: _____ (Example: XO, OX - See Page 3)

Active Insert (X)

Inactive Insert (O)

Stationary Insert (S)

Caution: Do not replace insert when glass alone is required.

9) Insert Color:

White

VS Tan

10) Bore Insert For Hardware:

Standard

2-Point

Sliding Patio Door Inserts, Glass, and Glazing Bead



Specify R.O. Width and Height when ordering parts listed below.

#2) VS Sliding Patio Door Active Insert (AIG) (70.0)

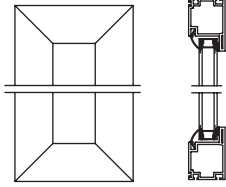

| COLOR | PART NUMBER |
|--------|-------------|
| White | 0500 |
| VS Tan | 0501 |

NOTE: Specify Type of Glass i.e. Clear, Low E, Bronze, etc. and Operating Code XO or OX.

#3) VS Sliding Patio Door Inactive Insert (IIG) (70.1)

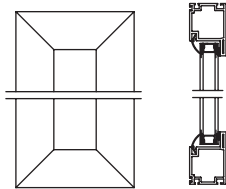

| COLOR | PART NUMBER |
|--------|-------------|
| White | 0500 |
| VS Tan | 0501 |

NOTE: Specify Type of Glass i.e. Clear, Low E, Bronze, etc. and Operating Code XO or OX.

#4) VS Sliding Patio Door Stationary/Transom Insert (TRIG) (70.5)

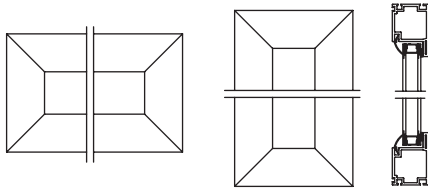

| COLOR | PART NUMBER |
|--------|-------------|
| White | 0500 |
| VS Tan | 0501 |

NOTE: Specify Type of Glass i.e. Clear, Low E, Bronze, etc.

#7) VS Sliding Patio Door Insul Glass w/Glazing Bead (RG) (70.2)



| GLAZING BEAD COLOR | PART NUMBER PER SET |
|--------------------|---------------------|
| White | 4061 |
| VS Tan | 4295 |

NOTE: Specify Type of Glass i.e. Clear, Low E, Bronze, etc.

#8) VS Sliding Patio Door Glazing Bead (GB) (73.0)

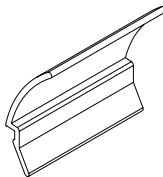

| GLAZING BEAD COLOR | PART NUMBER PER SET |
|--------------------|---------------------|
| White | 4061 |
| VS Tan | 4295 |



Sliding Patio Door Screen Parts

#11) Patio Door Screen (Exterior View) - #914
(Screen shown is for an XO Door)

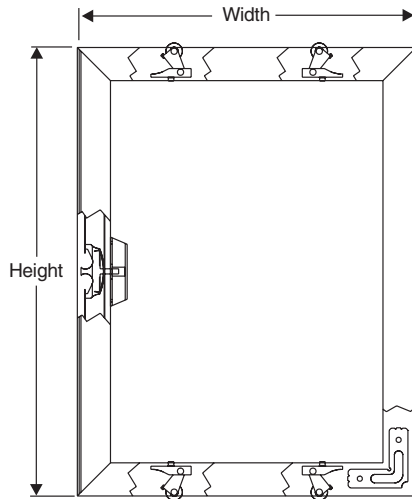

| COLOR | PART NUMBER |
|--------|-------------|
| White | 5013 |
| VS Tan | 5014 |

| <u>Unit Height</u> | <u>Standard Glass Height</u> | <u>French Glass Height</u> | <u>Screen Height</u> |
|--------------------|------------------------------|----------------------------|----------------------|
| 6-8 | 74 | 68-3/8 | 77-7/16" |
| 7-0 | 78 | 72-3/8 | 81-7/16" |
| 8-0 | 90 | 84-3/8 | 93-7/16" |

| <u>Unit Width</u> | <u>Standard Glass Width</u> | <u>French Glass Width</u> | <u>Screen Width</u> |
|-------------------|-----------------------------|---------------------------|---------------------|
| 5-0 | 25-7/8" | 21-5/8 | 30-1/8" |
| 6-0 | 31-7/8" | 27-5/8 | 36-1/8" |
| 6-6 | 34-7/8" | 30-5/8 | 39-1/8" |
| 8-0 | 43-7/8" | 39-5/8 | 48-1/8" |

#11) VS Sliding Patio Door Screen (SC) (70.3)

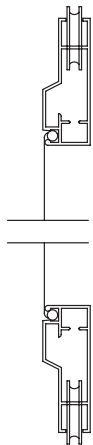

| COLOR | PART NUMBER |
|--------|-------------|
| White | 5013 |
| VS Tan | 5014 |

NOTE: Specify Operating Code XO or OX.

#21) Door Screen Roller Assembly #914 Screen (72.0)

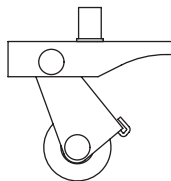

| FINISH | PART NUMBER |
|-----------------|-------------|
| Zinc Dichromate | 972403 |
| Stainless Steel | 972893 |

Sliding Patio Door Screen Parts



VS Sliding Patio Door Screen Latch and Spring - #914 (72.0)

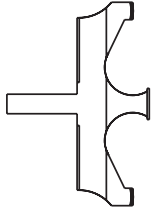

Screen Latch



Screen Spring

| LATCH PART NUMBER | SPRING PART NUMBER |
|----------------------|-----------------------|
| 980547 | 980548 |

NOTE: Needed when replacing inside handle.

#28) Sliding Patio Door Screen Handle Set - #914 (72.0)

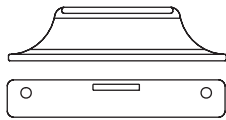

Inside Handle

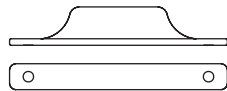

Outside Pull



Screen Latch Button

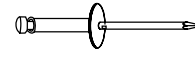

Latch Handle Rivets
(Two Per Handle)

| PART NUMBER |
|-------------|
| 972404 |

NOTE: Complete set includes Inside Handle, Outside Pull, Screen Latch Button, Screen Latch, and Rivets.

#12) VS Sliding Patio Door Screen Track (71.0)
Extrusion #6109-V

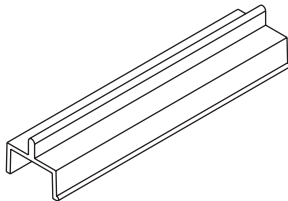

| COLOR | PART NUMBER |
|--------|-------------|
| White | 800006 |
| VS Tan | 800036 |

VS Sliding Patio Door Screen Keeper w/Screws (72.0)

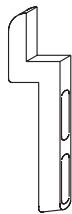

| PART NUMBER |
|-------------|
| 972030 |

Screen Spline (194.2)
Extrusion #1018

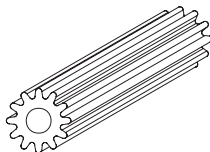

| PART NUMBER |
|-------------|
| 740689 |

#19) Screen Door Top Rail Guide (72.0)



| PART NUMBER |
|-------------|
| 980363 |



VISIONS 2000

Sliding Patio Door Horizontal Parts (71.0)

Specify R.O. Width and Height When Ordering Parts Listed Below.

#13) VS Sliding Patio Door Sill Track w/Cap
Extrusion #6108-V

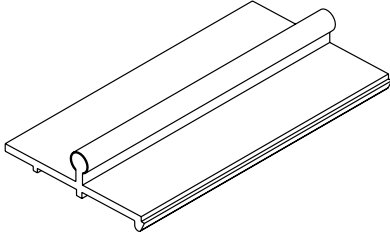

| COLOR | PART NUMBER |
|--------|-------------|
| White | 800123 |
| VS Tan | 800124 |

#25) VS Sliding Patio Door Stainless Steel Track Cap

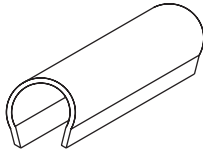

| PART NUMBER |
|-------------|
| 800052 |

#15) VS Sliding Patio Door Small Mull Cover
Extrusion #2322-V

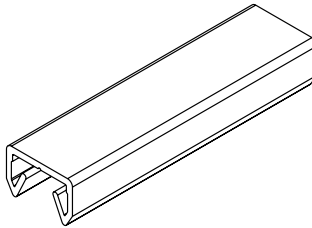

| FINISH | SIZE BY R.O. 1-PANEL PART NUMBER | SIZE BY R.O. 2-PANEL PART NUMBER | 14'6" PIECES (194.0) PART NUMBER | PRECUT IN INCHES (194.5) PART NUMBER |
|--------|--|--|--|--|
| White | 800125 | 800126 | 760481 | 100341 |
| VS Tan | 800127 | 800128 | 760544 | 100342 |

Sliding Patio Door Vertical Parts (71.1)



Specify R.O. Width and Height when ordering parts listed below.

VS Sliding Patio Door Interlock (Active) {E 11-96}
Extrusion #6107-V



Replace with #26

#26) VS Sliding Patio Door Interlock (Active) {S 11-96}
Extrusion #6097-V

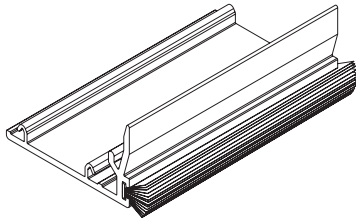

| COLOR | PART NUMBER |
|--------|-------------|
| White | 800162 |
| VS Tan | 800163 |

VS Sliding Patio Door Interlock (Inactive) {E 11-96}
Extrusion #6107-V

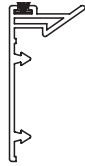

Replace with #27

#27) VS Sliding Patio Door Interlock (Inactive) {S 11-96}
Extrusion #6097-V

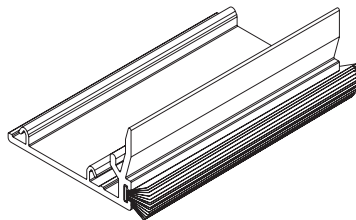

| COLOR | PART NUMBER |
|--------|-------------|
| White | 800164 |
| VS Tan | 800165 |

VS French Sliding Patio Door Interlock (Active and Inactive)
Extrusion #6096-V

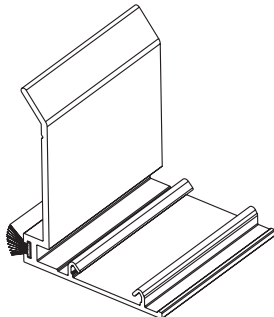

| COLOR | 14'6" PIECE (194.0) PART NUMBER | ACTIVE PART NUMBER | INACTIVE PART NUMBER |
|--------|---------------------------------------|-----------------------|-------------------------|
| White | 760985 | 803040 | 803042 |
| VS Tan | 760986 | 803041 | 803043 |



VISIONS 2000

Sliding Patio Door Vertical Parts

Specify R.O. Width and Height when ordering parts listed below.

#9) VS Sliding Patio Door Frame & Interlock White Pile Weather Strip w/o Center Fin
28018 750 WHWP
PB8827

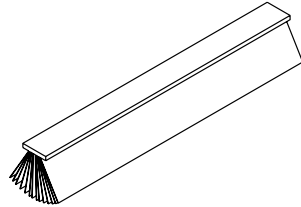

| |
|---|
| PRECUT IN INCHES (194.5) PART NUMBER |
| 105355 |

#15) VS Sliding Patio Door Small Mull Cover
Extrusion #2322-V

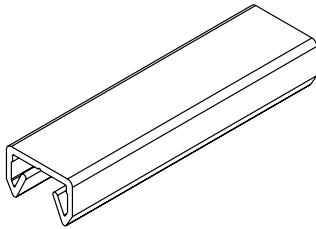

| COLOR | 14'6" PIECES (194.0) PART NUMBER | PRECUT IN INCHES (194.5) PART NUMBER |
|--------------|---|---|
| White | 760481 | 100341 |
| VS Tan | 760544 | 100342 |

Sliding Patio Door Miscellaneous Parts (72.0)



#10) VS Sliding Patio Door Sash Pile Weather Strip w/Center Fin
27018 758 WHWF
7826-6601-3

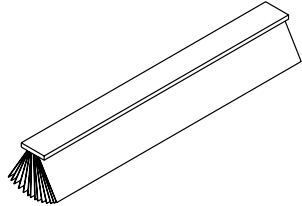

| |
|---|
| PRECUT IN INCHES (194.5) PART NUMBER |
| 100350 |

#14) Patio Door Roller Assembly w/Screw

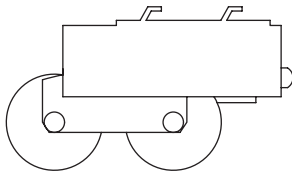

| FINISH | PART NUMBER |
|-----------------|-------------|
| Zinc Dichromate | 972459 |
| Stainless Steel | 972537 |

#16) VS Sliding Patio Door Hole Plug



| COLOR | ACTIVE INSERT 1/4" HOLE PLUG PART NUMBER | ACTIVE INSERT 1/2" HOLE PLUG PART NUMBER | 3/8" HOLE PLUG FOR MULLING PART NUMBER |
|--------|--|--|--|
| White | 981552 | 981554 | 980572 |
| VS Tan | 981553 | 981555 | 981458 |

#17) VS Sliding Patio Door #8 x 1/2" Tek Phillips Pan Head Zinc Steel Screw

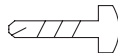

| |
|--------------------|
| PART NUMBER |
| 971395 |



Sliding Patio Door Miscellaneous Parts (72.0)

Mortise Lock
#6 x 32 x 1/2" Phillips Truss Head Screw

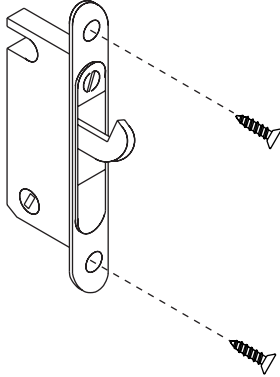

| FINISH | PART NUMBER |
|-----------------|-------------|
| Standard | 972462 |
| Stainless Steel | 972647 |

2-Point Mortise Lock and Keeper



Lock Keeper

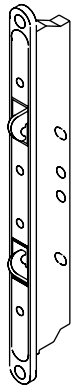

Mortise Lock

| LOCK KEEPER PART NUMBER | MORTISE LOCK PART NUMBER |
|----------------------------|-----------------------------|
| 940440 | 940439 |

#20) VS Sliding Patio Door 1/16" x 1/4" Double Face Glazing Tape

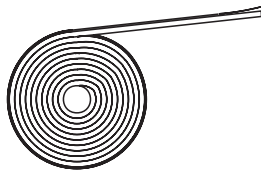

| PART NUMBER |
|-------------|
| 973211 |

Sliding Patio Door Miscellaneous Parts (72.0)



VS Patio Vinyl Sill Bumper - 3-1/2"
Extrusion #6110

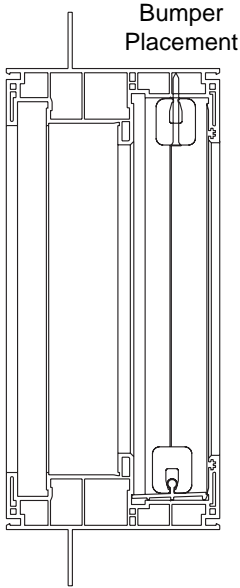
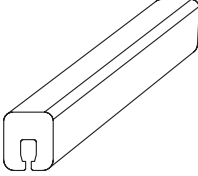

| COLOR | PART NUMBER |
|--------|-------------|
| White | 760524 |
| VS Tan | 760568 |



Sliding Patio Door Miscellaneous Parts (72.0)

#22) Wood Handle Set

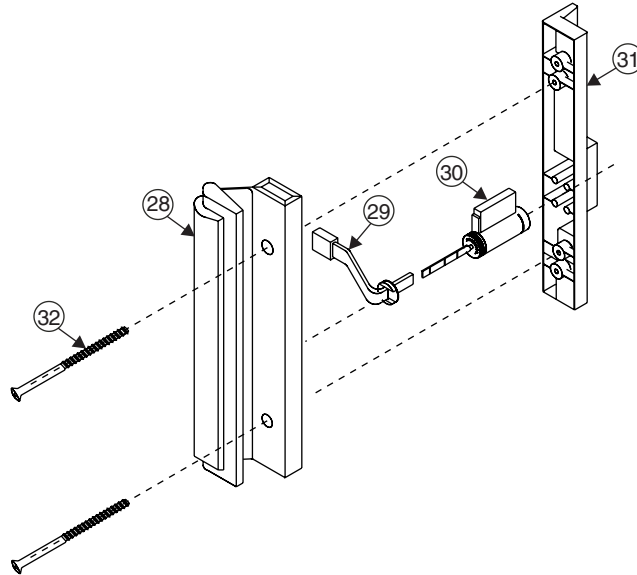

- | | |
|--|---------|
| 22) Complete Wood Handle Set (Includes #18, 28, 29, and 31) | Page 23 |
| 28) Inside Handle | Page 23 |
| 29) Lock Activator Lever w/Grommet and Black Button | Page 23 |
| 30) Keyed Cylinder Lock | Page 23 |
| 31) Outside Handle | Page 23 |
| 32) #8-32 Oval Head 2-1/8" Screw | Page 28 |

Sliding Patio Door Miscellaneous Parts (72.0)



#30) Keyed Cylinder Lock

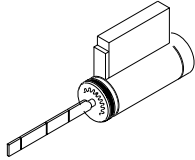

| PART NUMBER |
|-------------|
| 972031 |

#29) Lock Activator Lever with Grommet Button

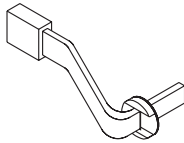

| PART NUMBER |
|-------------|
| 972133 |

#28) Inside Handle

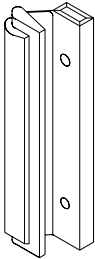

| FINISH | PART NUMBER |
|--------|-------------|
| White | 972460 |
| VS Tan | 972531 |

#31) Outside Handle

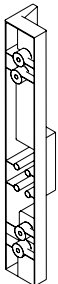

| FINISH | PART NUMBER |
|--------|-------------|
| White | 972461 |
| VS Tan | 972532 |

#18) VS Sliding Patio Door Jamb Latch Keeper

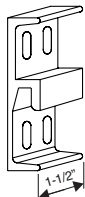

| COLOR | PART NUMBER |
|--------|-------------|
| White | 972463 |
| VS Tan | 972533 |

#22) Complete Wood Handle Set (Includes #18, 28, 29, and 31)

| FINISH | PART NUMBER |
|--------|-------------|
| White | 972464 |
| VS Tan | 972519 |



VISIONS 2000

Sliding Patio Door Miscellaneous Parts (72.0)

Bright Brass Handle Set

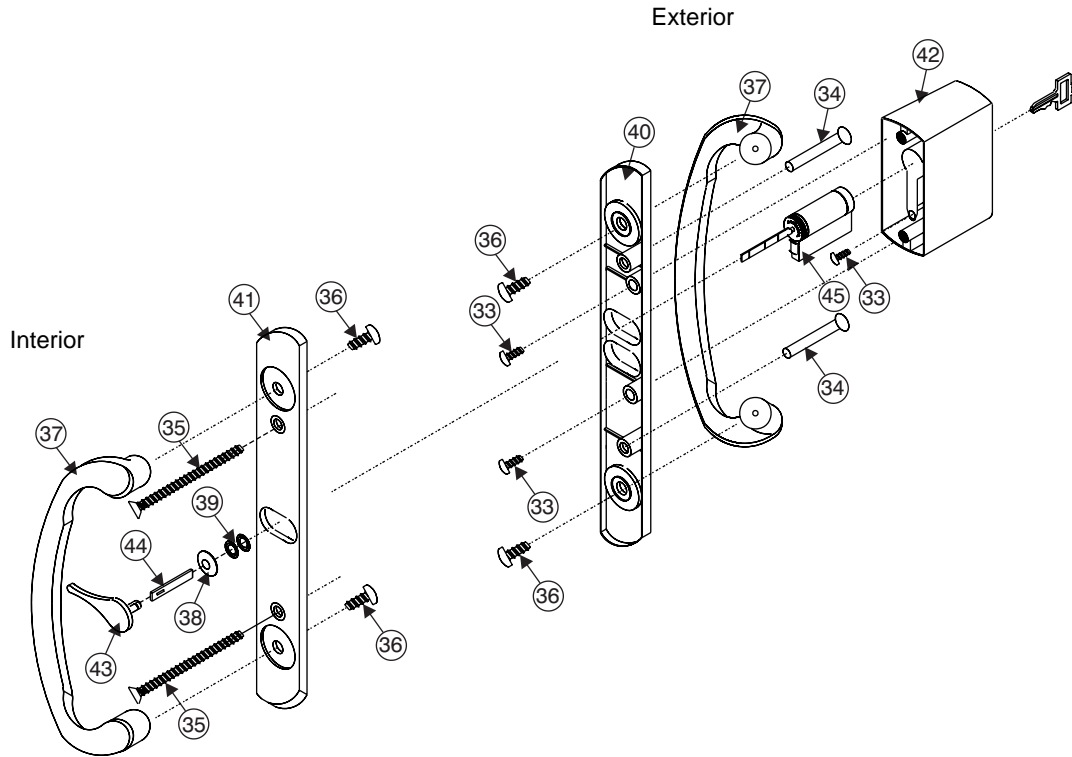

- | | | |
|-----|---|---------|
| 33) | #8 x 3/8" Truss Head Screw | Page 28 |
| 34) | #10-24 Blind Nut | Page 28 |
| 35) | Escutcheon Plate Handle Screw #10-24 x 1-1/2" | Page 28 |
| 36) | Serrated Truss Head Handle Screw #10-24 x 1/2" | Page 28 |
| 37) | Solid Brass Handle Set | Page 26 |
| 38) | Handle Set Nylon Washer | Page 27 |
| 39) | Push Nut (Qty. 2) | Page 27 |
| 40) | Exterior Escutcheon Plate | Page 26 |
| 41) | Interior Escutcheon Plate | Page 26 |
| 42) | Keylock Housing | Page 27 |
| 43) | Thumbturn | Page 27 |
| 44) | Tailpiece for Solid Brass Handle Set | Page 27 |
| 45) | Keyed Cylinder Lock | Page 27 |

Sliding Patio Door Miscellaneous Parts (72.0)



Sliding Door Handle Set Complete

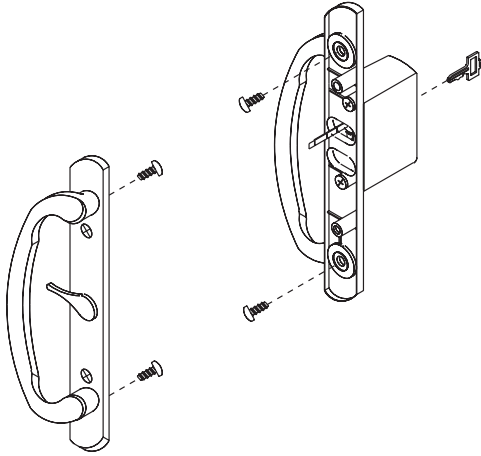

| FINISH | PART NUMBER |
|---------------|-------------|
| White | 940319 |
| VS Tan | 940451 |
| Bright Brass | 940012 |
| Antique Brass | 940166 |
| Chrome | 940165 |

Complete Outside Handle Set

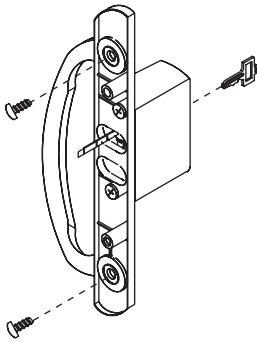

| FINISH | PART NUMBER |
|---------------|-------------|
| White | 940827 |
| VS Tan | 940830 |
| Bright Brass | 940828 |
| Antique Brass | 940831 |
| Chrome | 940829 |

Complete Inside Handle Set

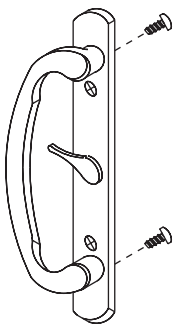

| FINISH | PART NUMBER |
|---------------|-------------|
| White | 940449 |
| VS Tan | 940450 |
| Bright Brass | 940014 |
| Antique Brass | 940453 |
| Chrome | 940462 |



Sliding Patio Door Miscellaneous Parts (72.0)

#37) Interior/Exterior Handle

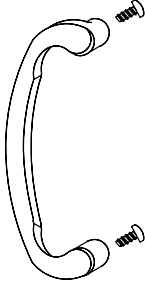

| FINISH | PART NUMBER |
|---------------|-------------|
| White | 940790 |
| VS Tan | 940822 |
| Bright Brass | 940150 |
| Antique Brass | 940791 |
| Chrome | 940792 |

#40) Exterior Escutcheon Plate



| FINISH | PART NUMBER |
|---------------|-------------|
| White | 940793 |
| VS Tan | 940823 |
| Bright Brass | 940153 |
| Antique Brass | 940794 |
| Chrome | 940795 |

#41) Interior Escutcheon Plate



| FINISH | PART NUMBER |
|---------------|-------------|
| White | 940796 |
| VS Tan | 940852 |
| Bright Brass | 940154 |
| Antique Brass | 940797 |
| Chrome | 940798 |

Sliding Patio Door Miscellaneous Parts (72.0)



#38) Handle Set Nylon Washer



| PART NUMBER |
|-------------|
| 940151 |

#39) Push Nut



| PART NUMBER |
|-------------|
| 940149 |

#43) Thumbturn

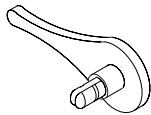

| FINISH | PART NUMBER |
|---------------|-------------|
| White | 940819 |
| VS Tan | 940863 |
| Bright Brass | 940156 |
| Antique Brass | 940820 |
| Chrome | 940821 |

#44) Tailpiece for Solid Brass Handle Set

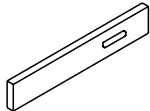

| PART NUMBER |
|-------------|
| 940157 |

#42) Keylock Housing

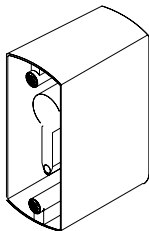

| FINISH | PART NUMBER |
|---------------|-------------|
| White | 940799 |
| VS Tan | 940833 |
| Bright Brass | 940155 |
| Antique Brass | 940800 |
| Chrome | 940818 |

#45) Keyed Cylinder Lock for Legacy Handleset

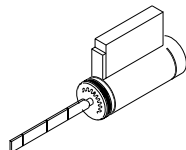

| PART NUMBER |
|-------------|
| 940489 |



Sliding Patio Door Miscellaneous Parts (72.0)

#32) #8-32 Oval Head 2-1/8" Screw



| FINISH | PART NUMBER |
|--------|-------------|
| White | 960171 |
| VS Tan | 960172 |

Screw Pack for Sliding Door Handle Set

#34) #10-24 Blind Nut

#35) #10-24 x 1-1/2" Escutcheon Plate Screw

#36) #10-24 x 1/2" Serrated Truss Head Handle Screw

#34) #10-24 Blind Nut

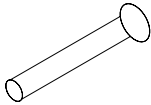

| FINISH | PART NUMBER |
|--------------|-------------|
| White | 971967 |
| VS Tan | 971968 |
| Bright Brass | 971950 |
| Chrome | 971953 |

#35) #10-24 x 1-1/2" Escutcheon Plate Screw

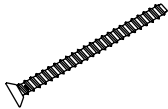

#36) #10-24 x 1/2" Serrated Truss Head Handle Screw



Sliding Patio Door Accessories



VS 1/2" - 5/8" Jamb Extension/Drywall Return
Extrusion #2327-V

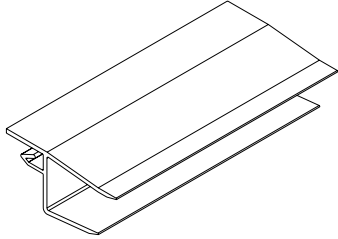

| COLOR | 14'6" PIECES (194.0) PART NUMBER | SPECIFIC LENGTH IN INCHES (194.5) PART NUMBER |
|--------|--|---|
| White | 760485 | 100356 |
| VS Tan | 760538 | 100357 |

VS 3/4" - 7/8" Jamb Extension/Drywall Return
Extrusion #2330-V

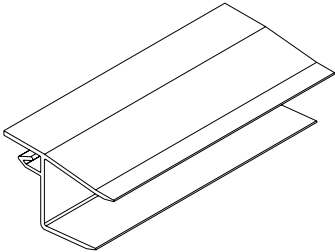

| COLOR | 14'6" PIECES (194.0) PART NUMBER | SPECIFIC LENGTH IN INCHES (194.5) PART NUMBER |
|--------|--|---|
| White | 760642 | 100358 |
| VS Tan | 760643 | 100359 |

VS Retro Z-Casing (All Products)
Extrusion #1044-V

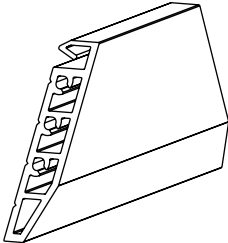

| COLOR | 14'6" PIECES (194.0) PART NUMBER | SPECIFIC LENGTH IN INCHES (194.5) PART NUMBER |
|--------|--|---|
| White | 760702 | 100366 |
| VS Tan | 760703 | 100367 |



Sliding Patio Door Accessories

Jamb Extension Clip
Extrusion #1076-V

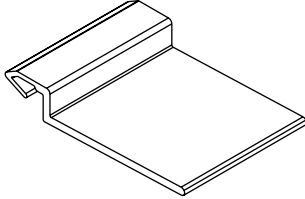

| |
|---|
| 69" PIECES (194.0) PART NUMBER |
| 760892 |

J-Channel w/o Nailing Fin
Extrusion #1060-V

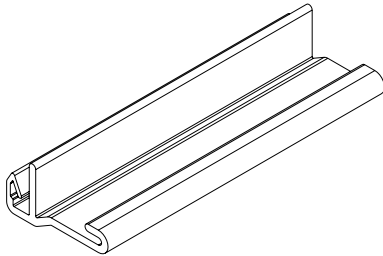

| COLOR | 14'6" PIECES (194.0) PART NUMBER | SPECIFIC LENGTH IN INCHES (194.5) PART NUMBER |
|--------------|---|--|
| White | 760931 | 100404 |
| VS Tan | 760932 | 100405 |

Brickmould
Extrusion #1084

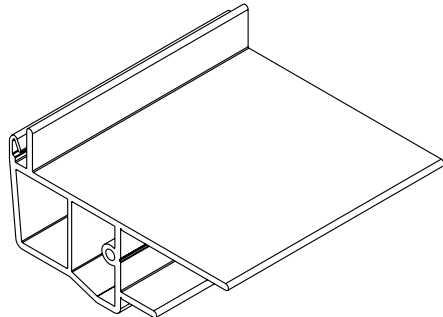

| COLOR | 14'6" PIECE (194.0) PART NUMBER | SPECIFIC LENGTH IN INCHES (194.5) PART NUMBER |
|--------------|--|--|
| White | 761113 | 761434 |
| VS Tan | 761114 | 761435 |

Drywall Extension
Extrusion #1065

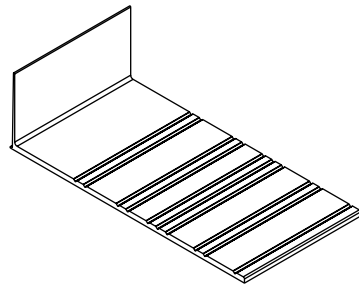

| COLOR | 14'6" PIECE (194.0) PART NUMBER |
|--------------|--|
| White | 761861 |
| VS Tan | 761862 |

Sliding Patio Door Accessories



Secondary Lock Kit (194.0)

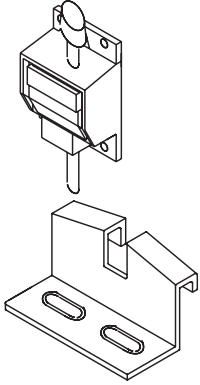

| FINISH | PART NUMBER | KEEPER ONLY PART NUMBER |
|--------|-------------|----------------------------|
| White | 940161 | 940860 |
| VS Tan | 940162 | 940861 |
| Bronze | 940160 | 940862 |